

1. 鍛造工程

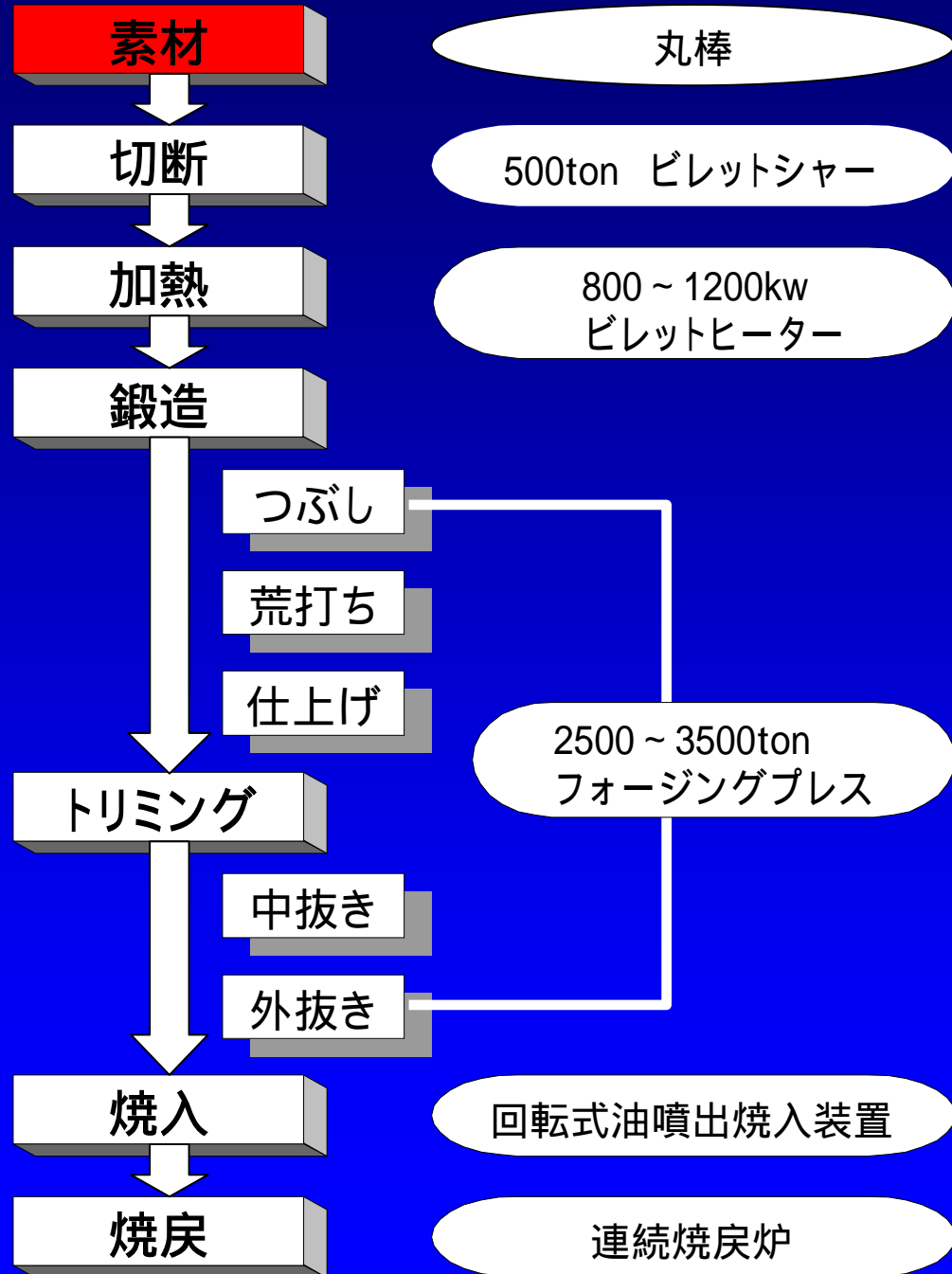

1. 鍛造工程

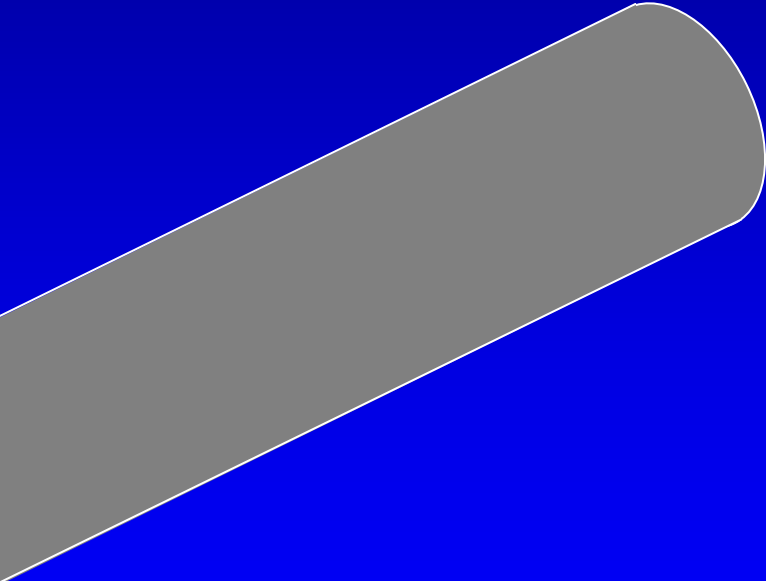
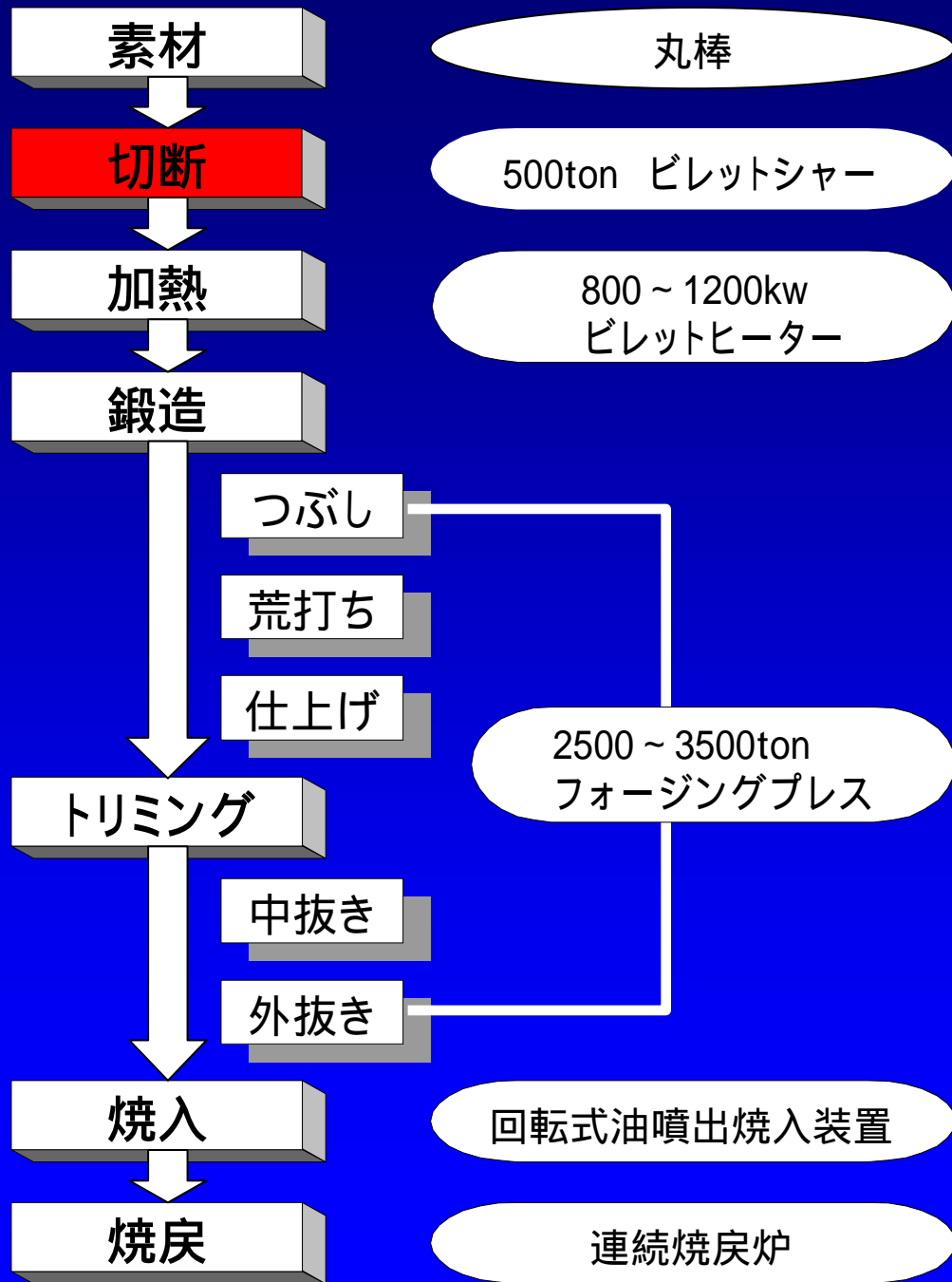
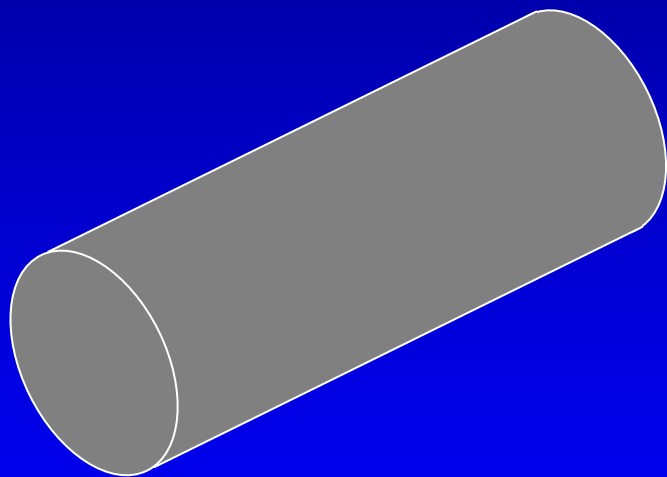

1. 鍛造工程

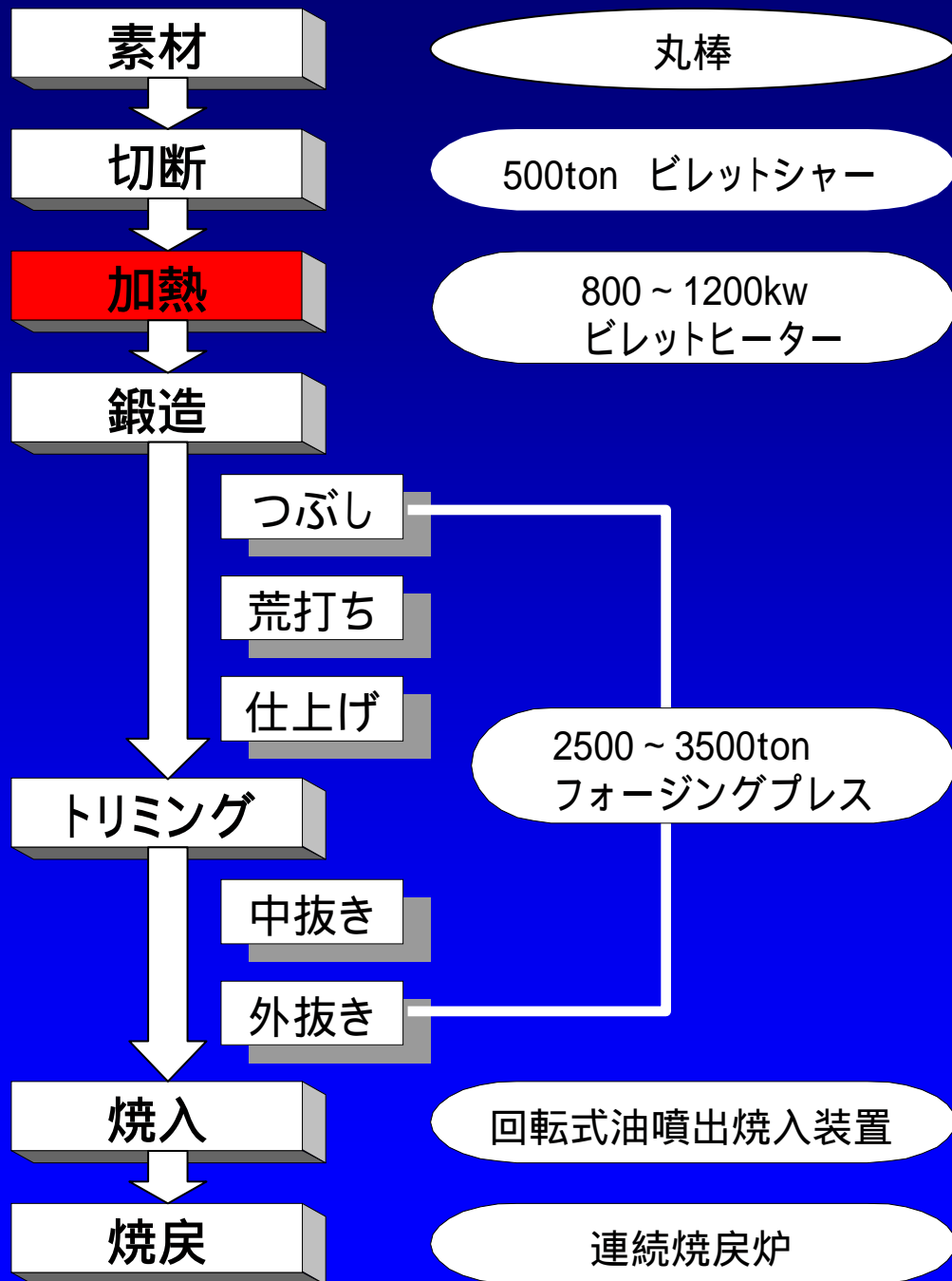
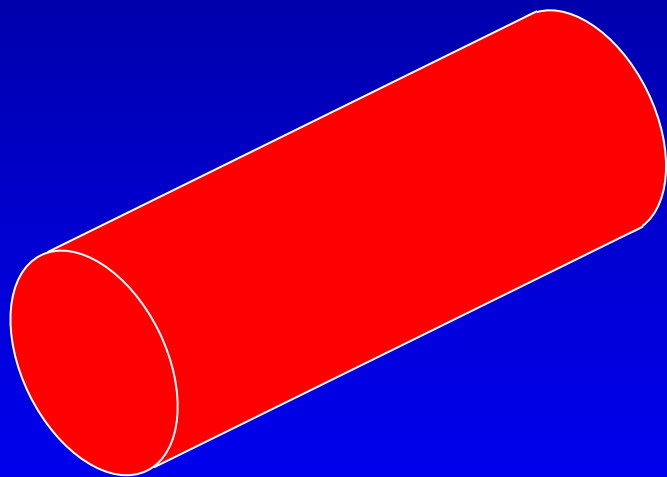

1. 鍛造工程

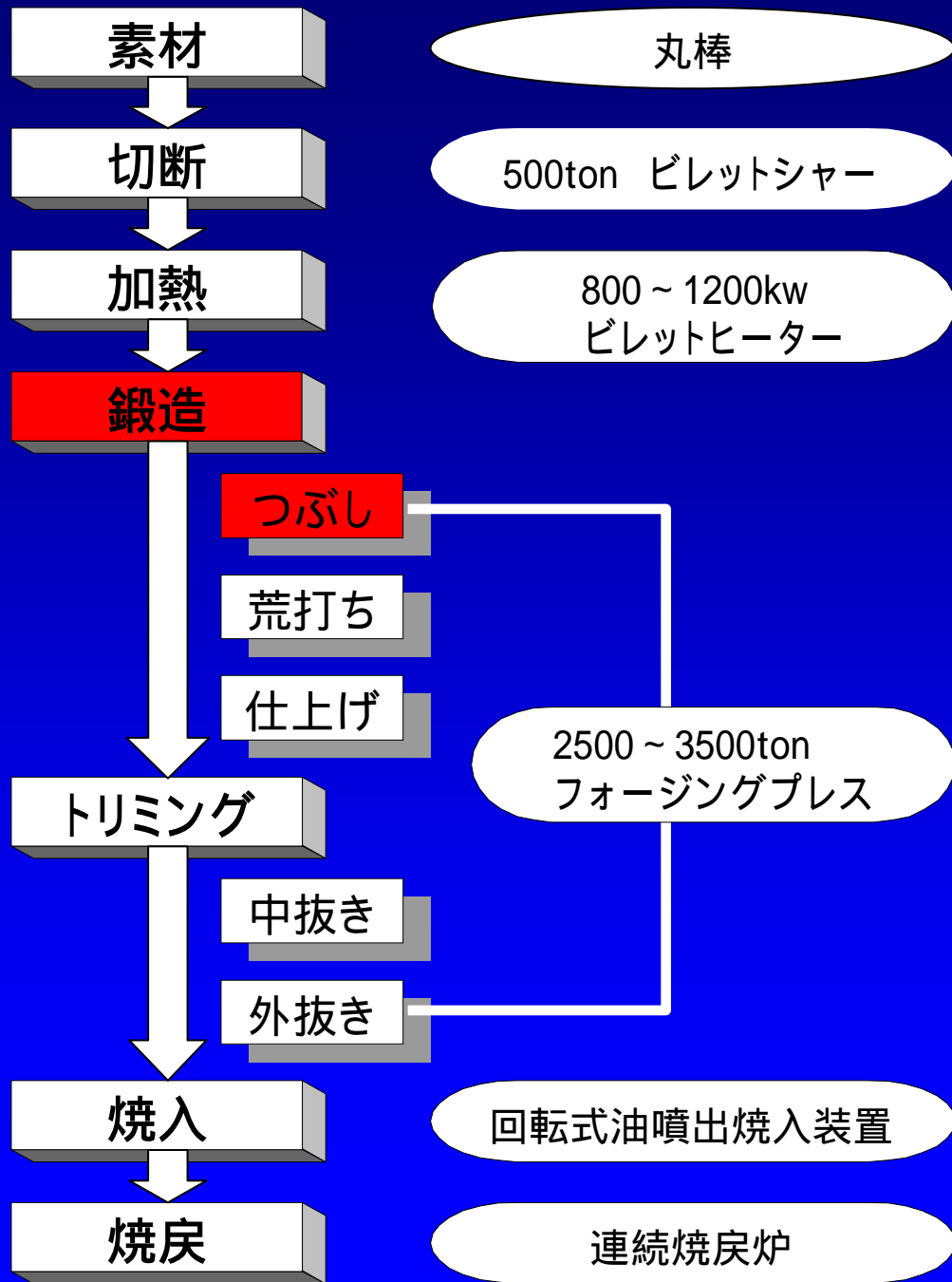
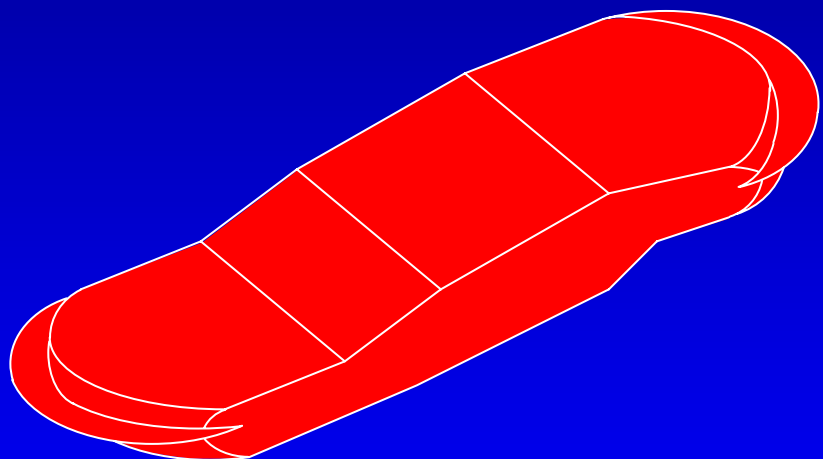

1. 鍛造工程

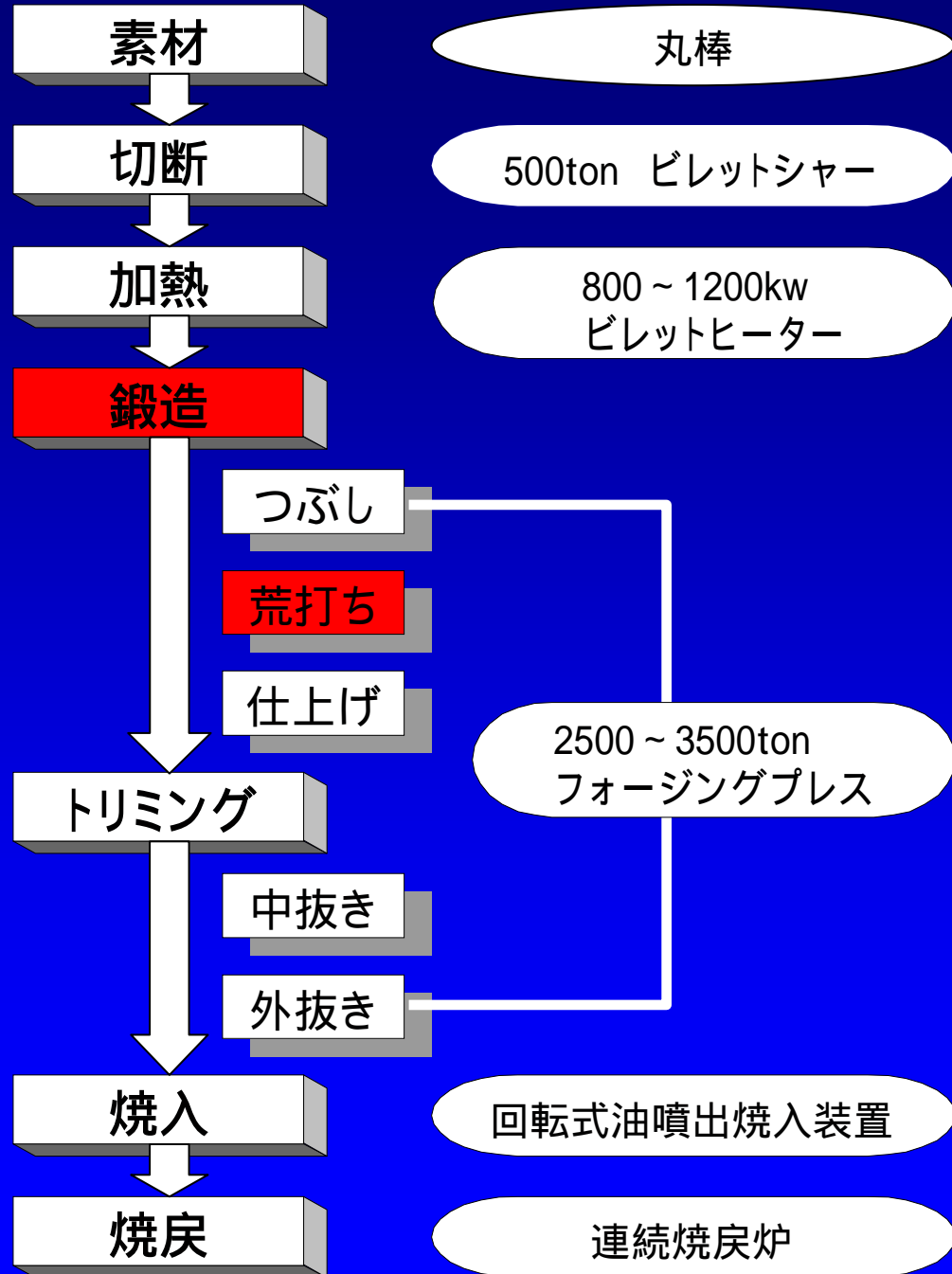
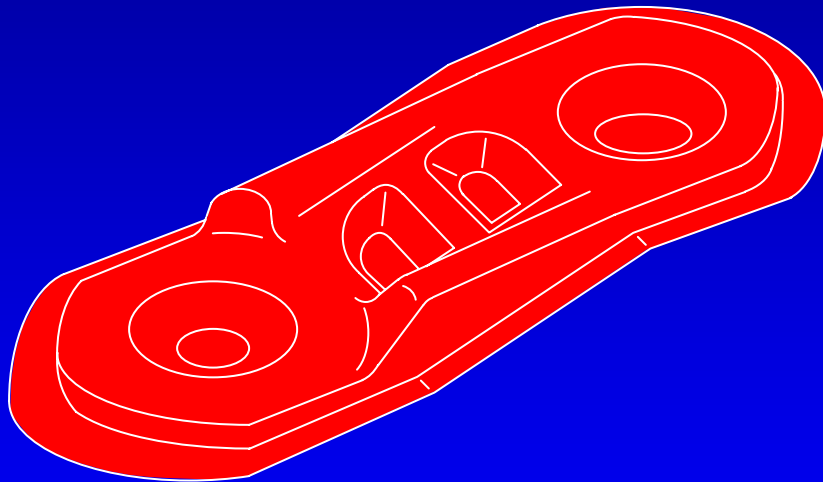

1. 鍛造工程

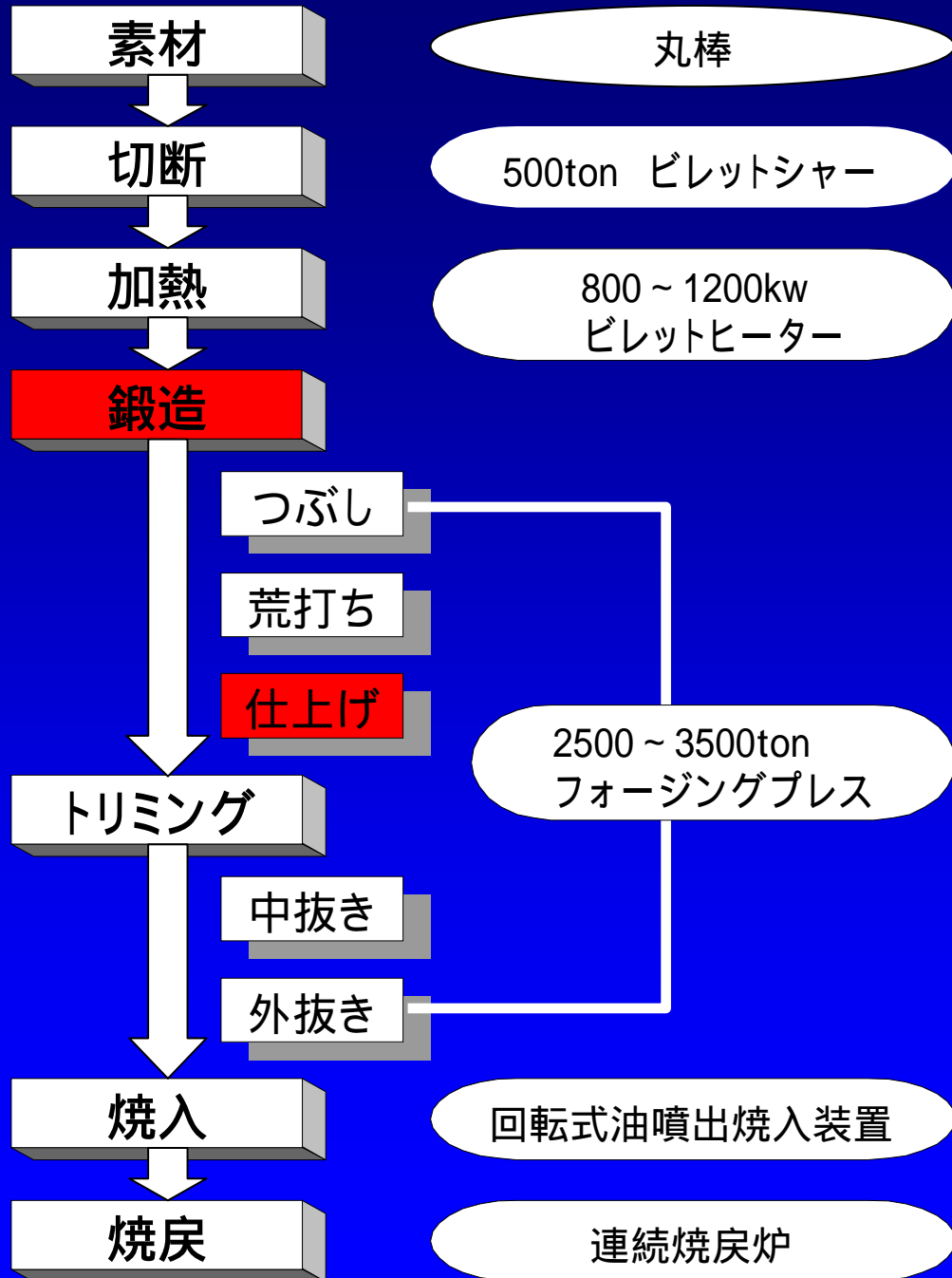
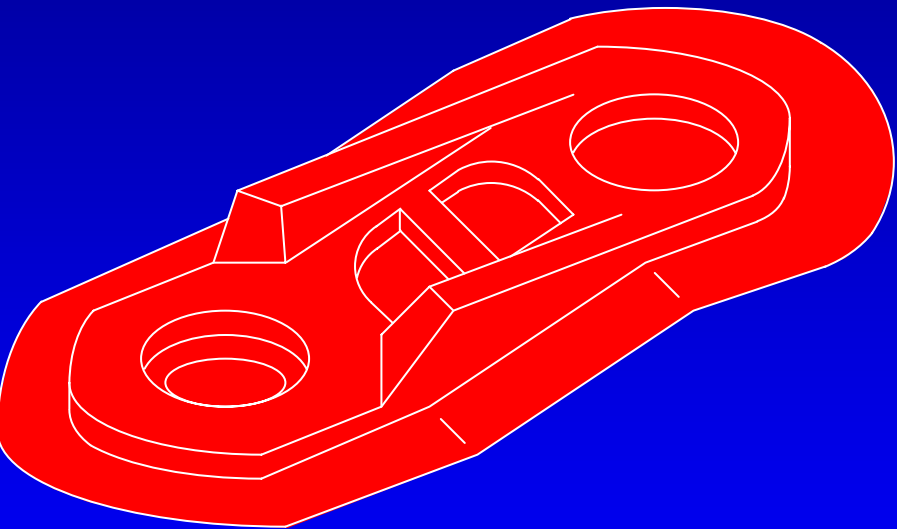

1. 鍛造工程

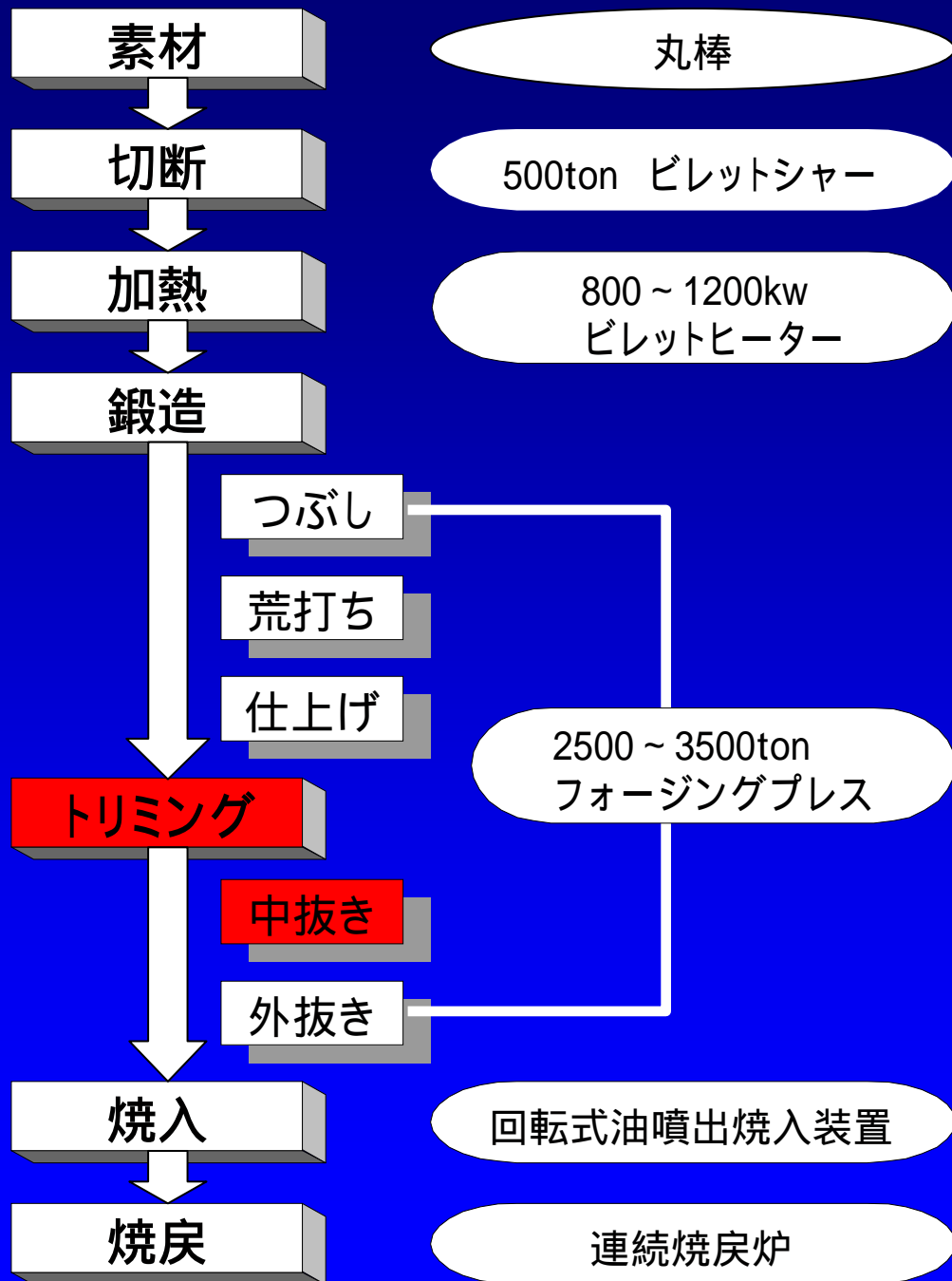
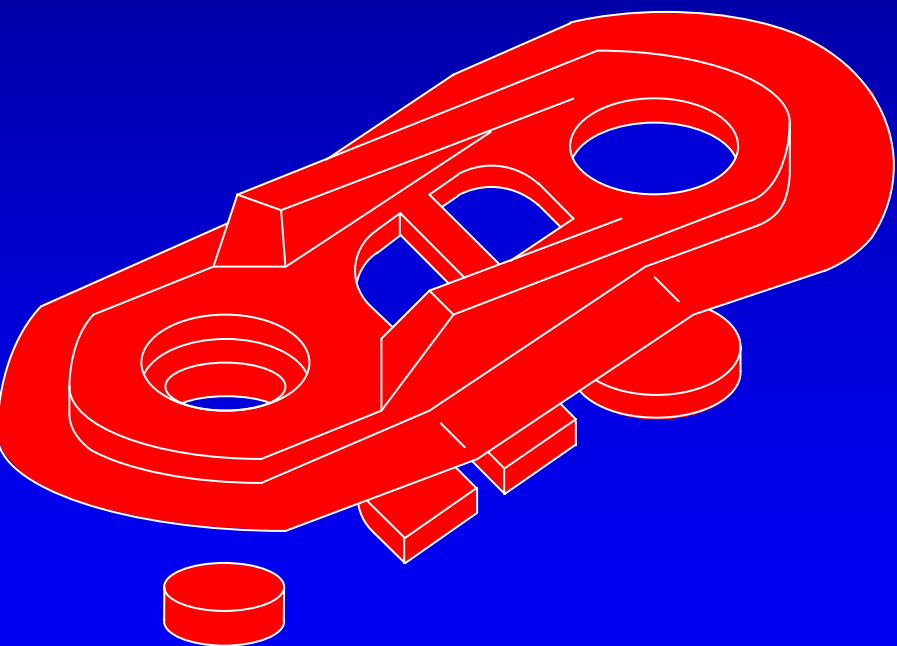

1. 鍛造工程

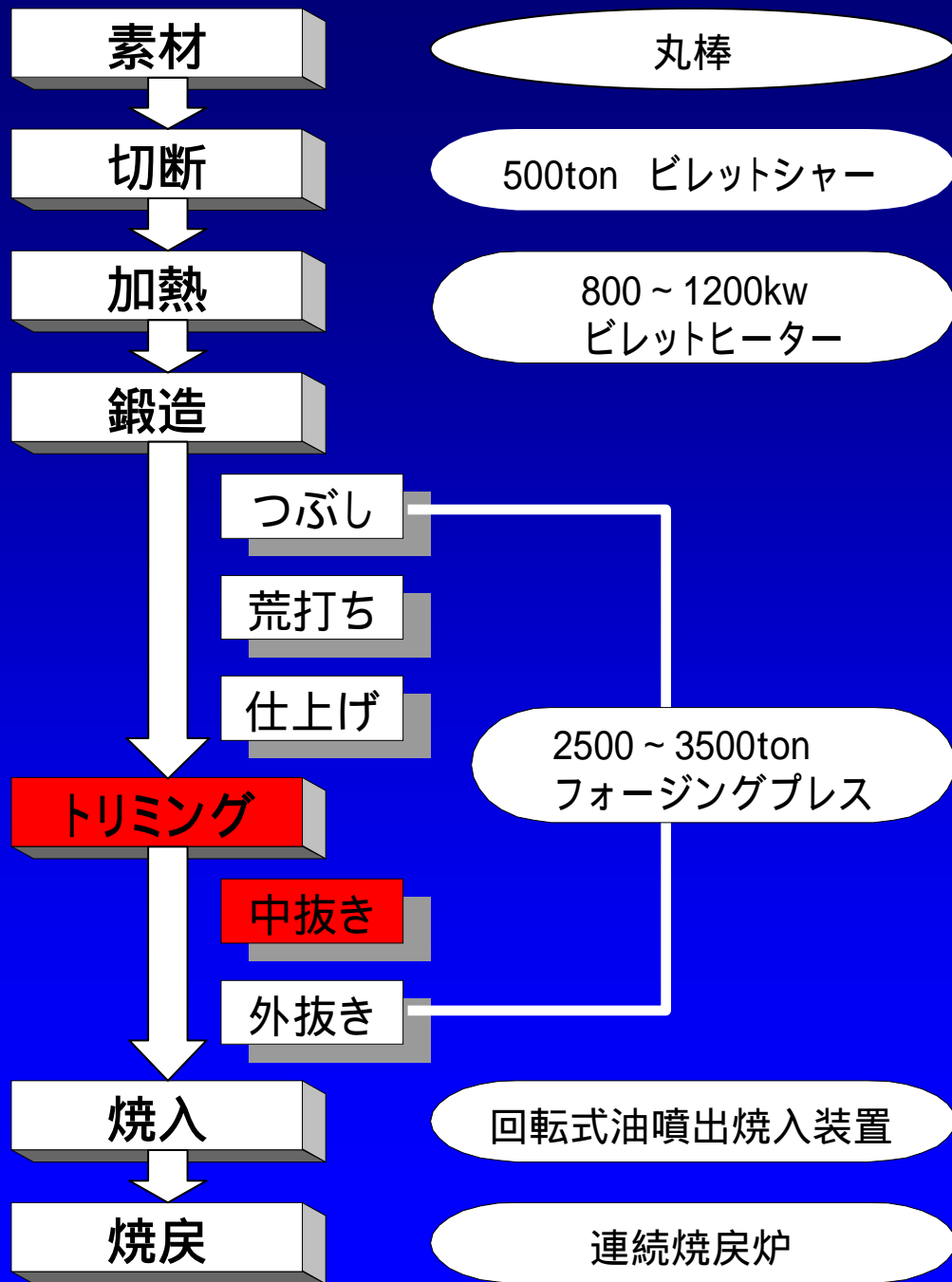
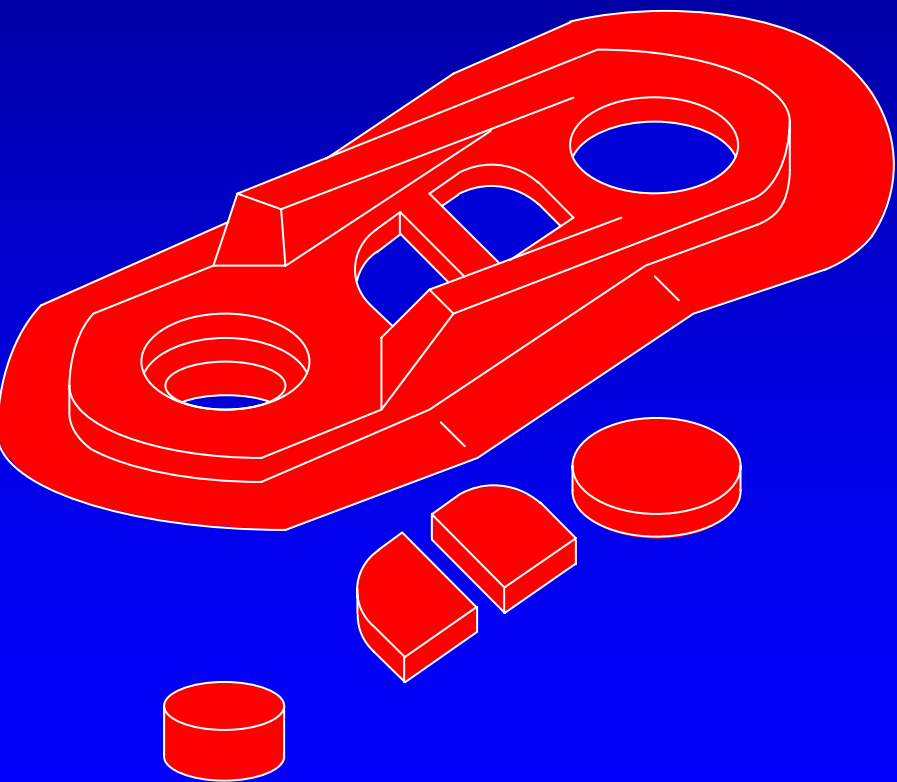

1. 鍛造工程

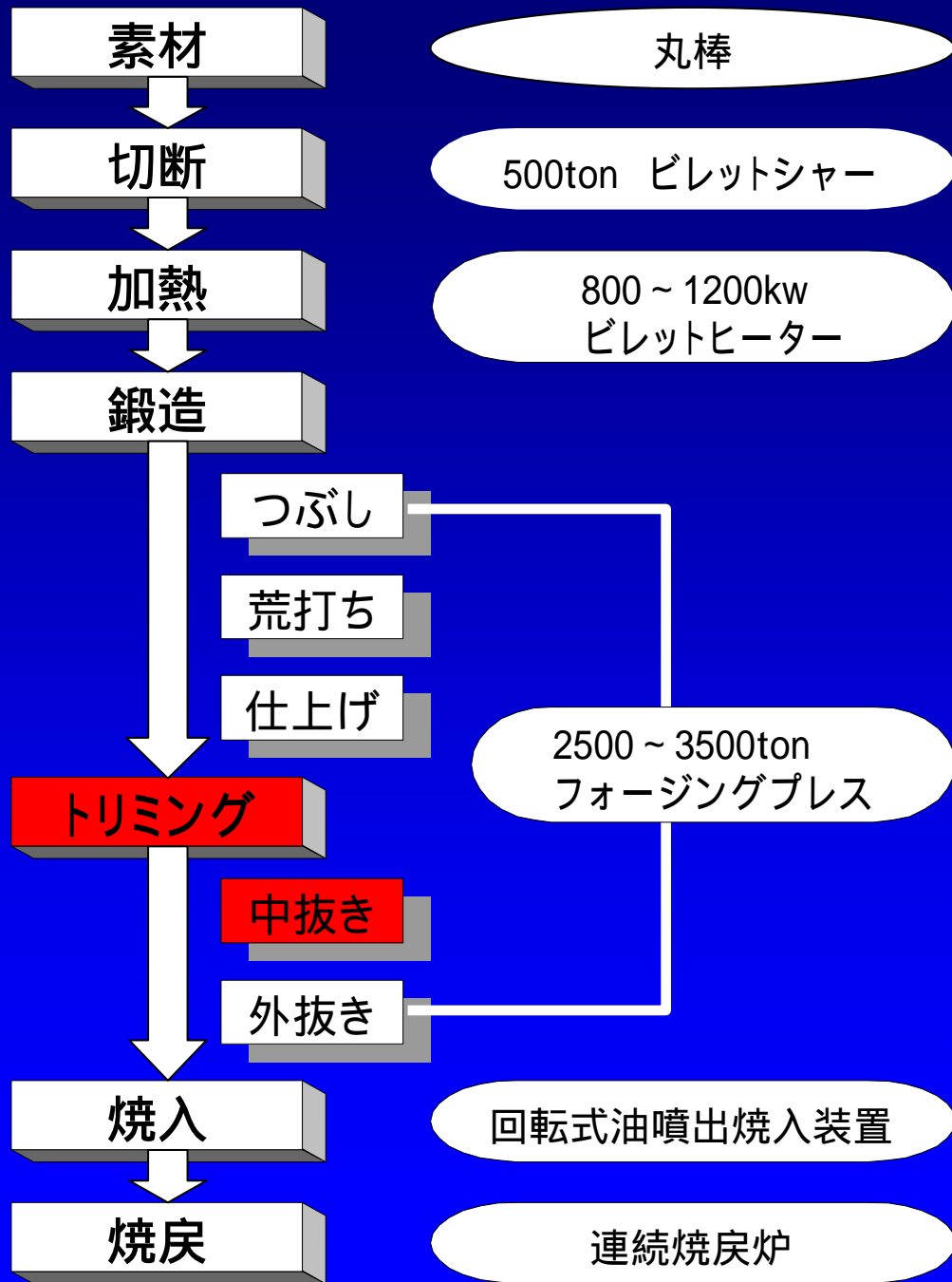
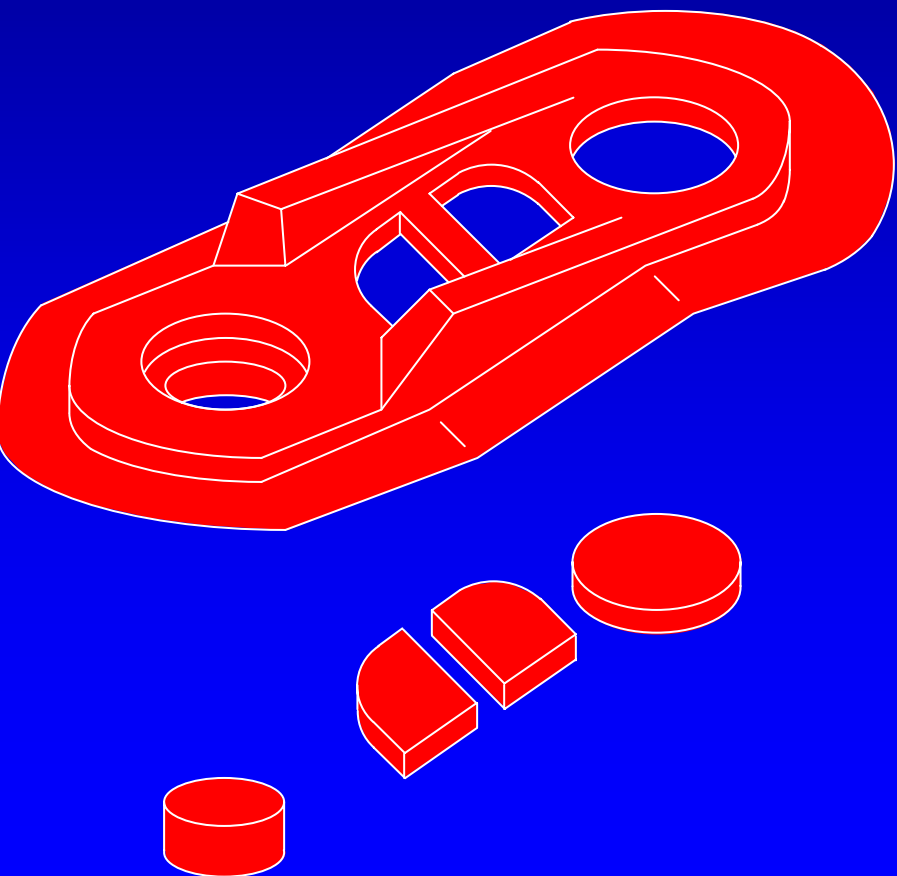

1. 鍛造工程

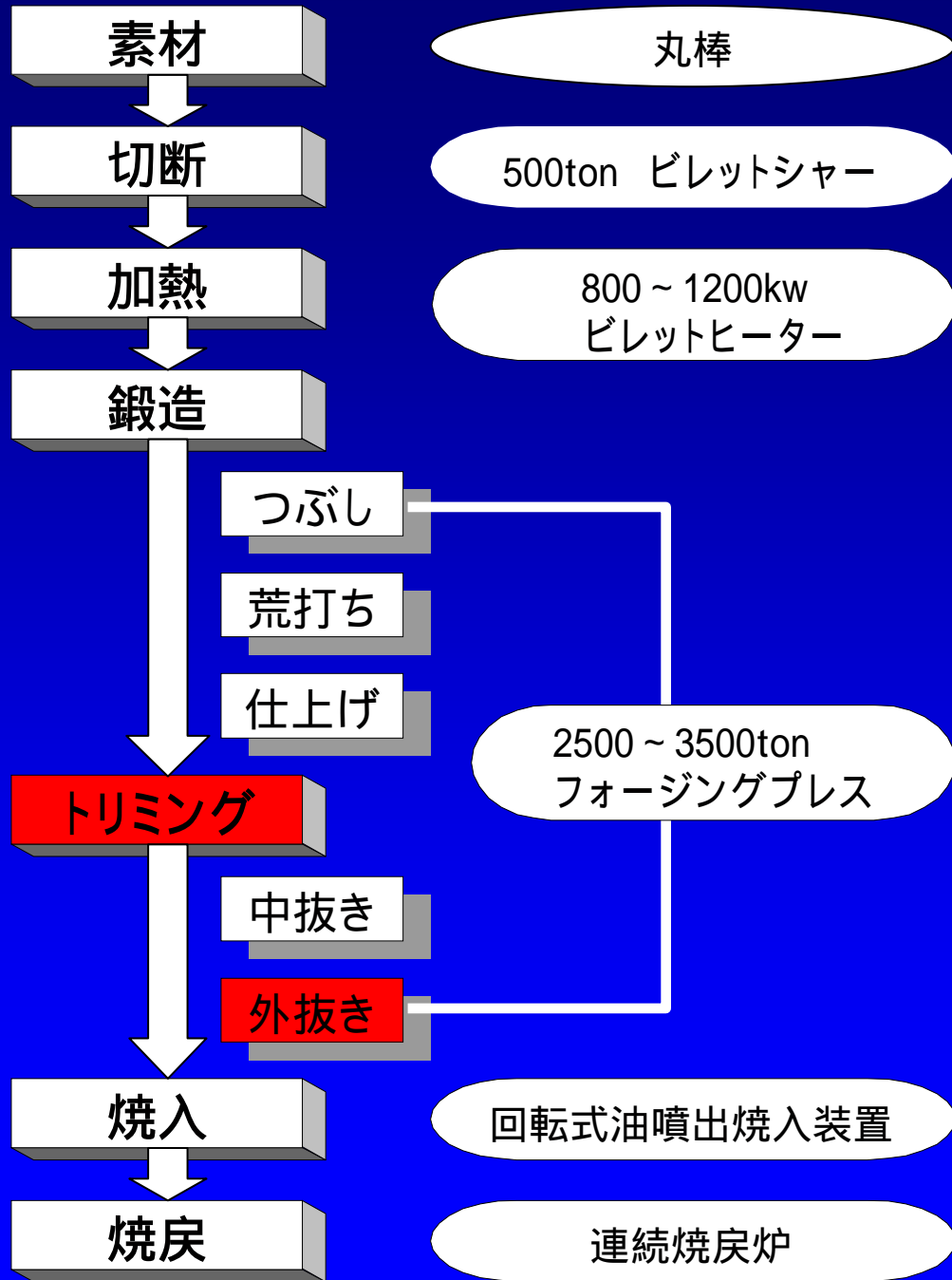
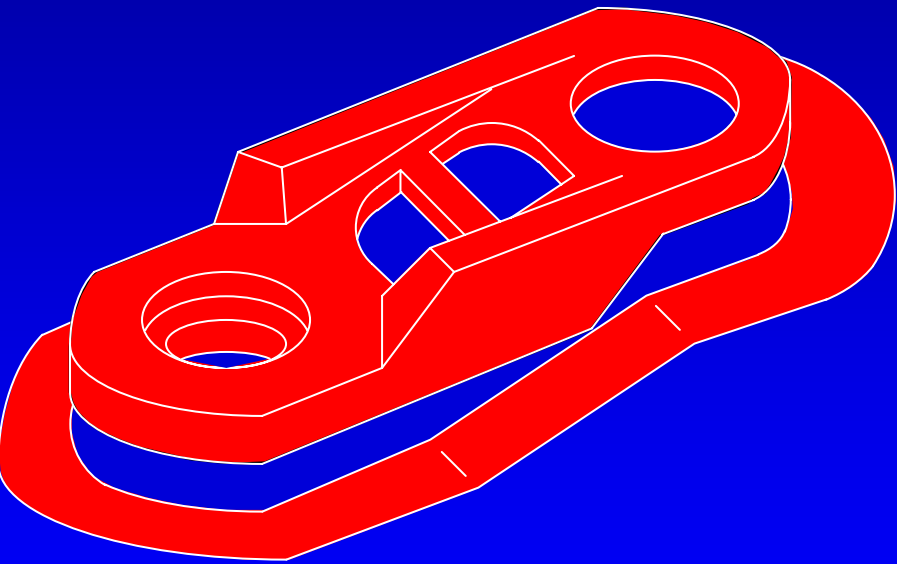

1. 鍛造工程

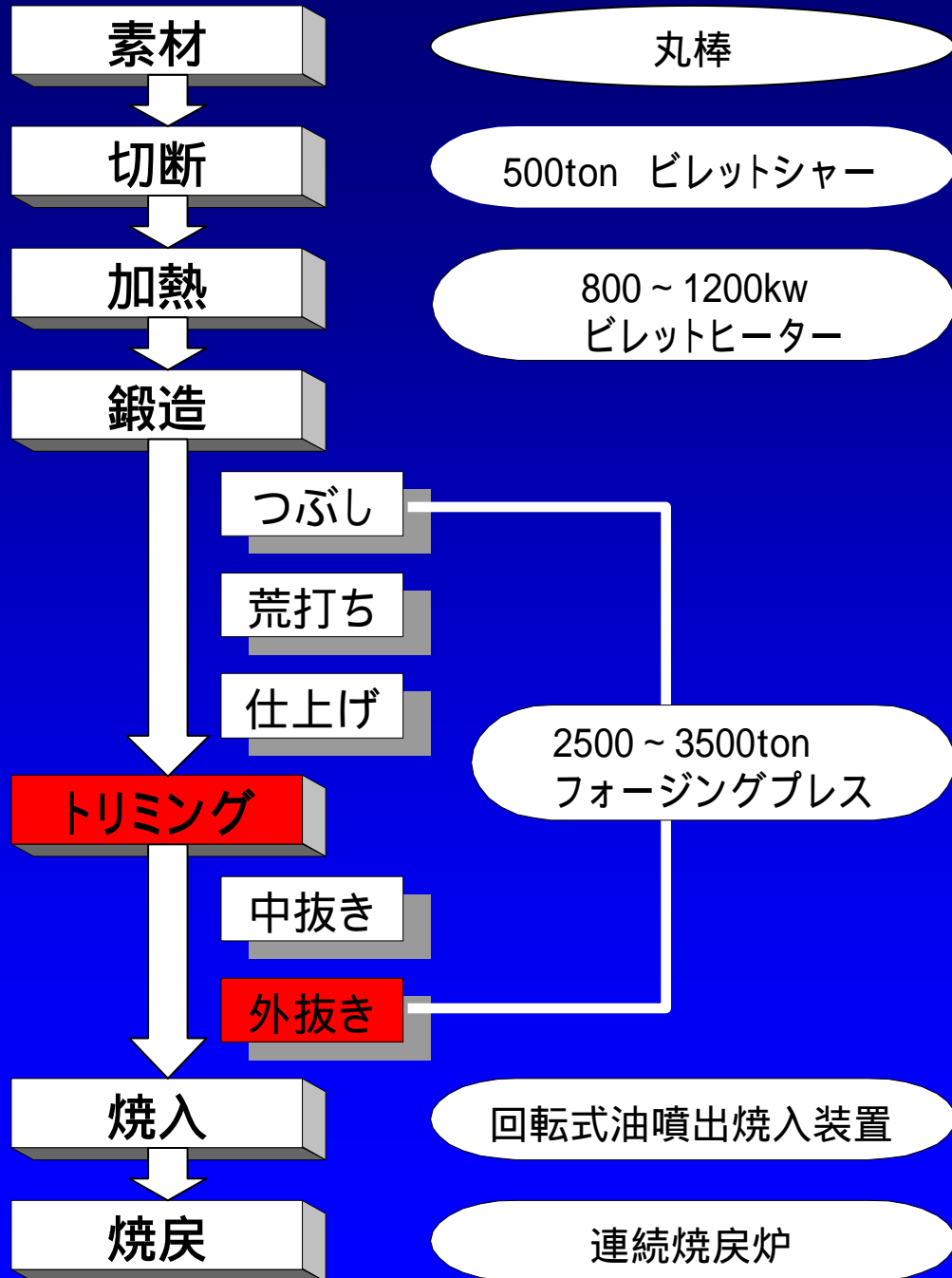
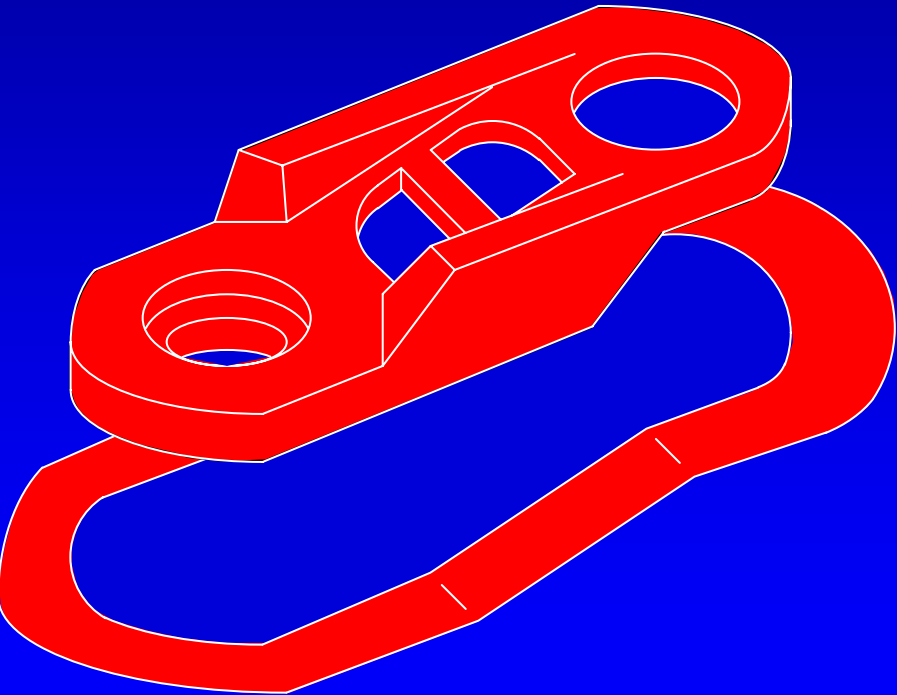

1. 鍛造工程

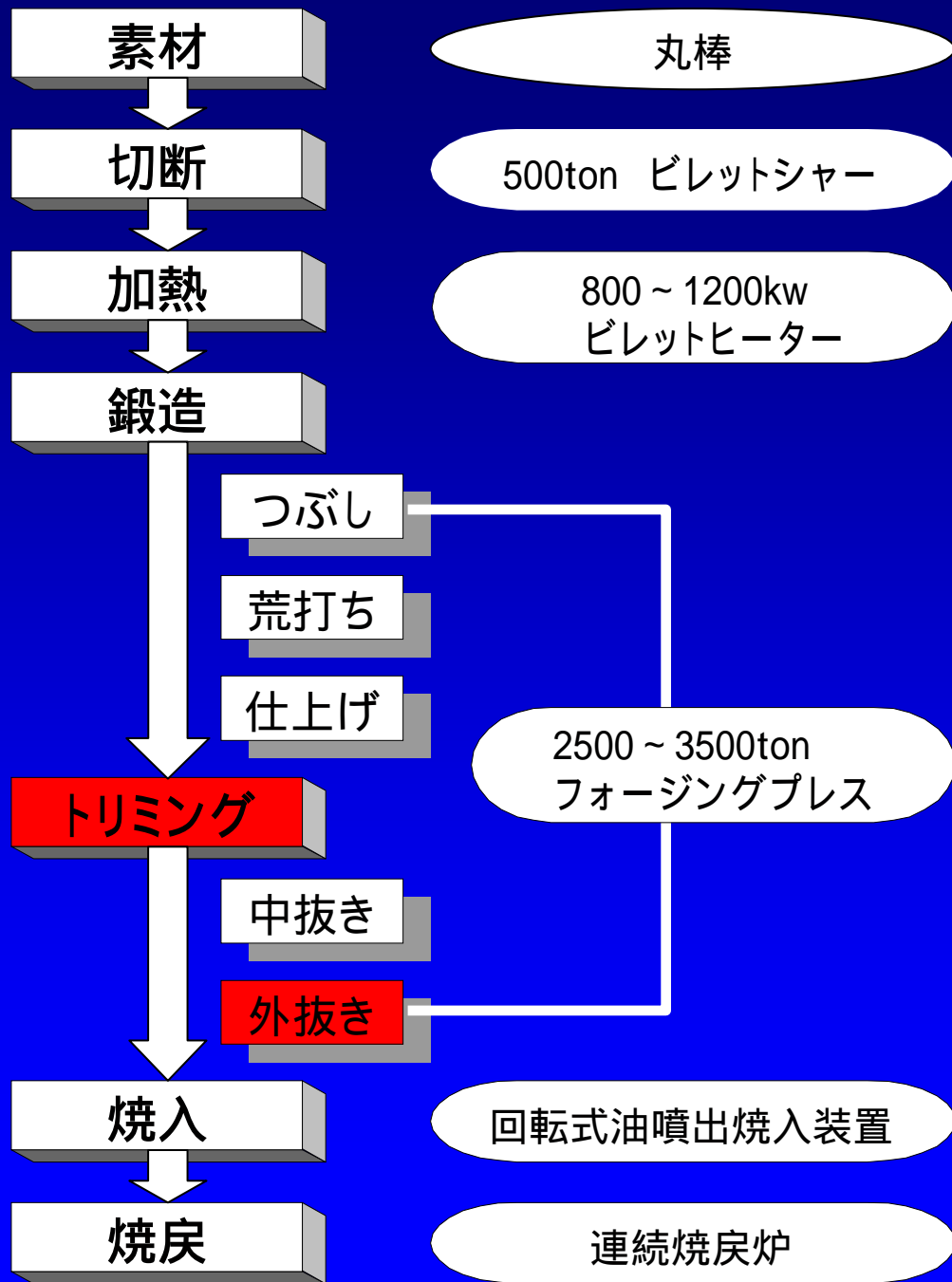
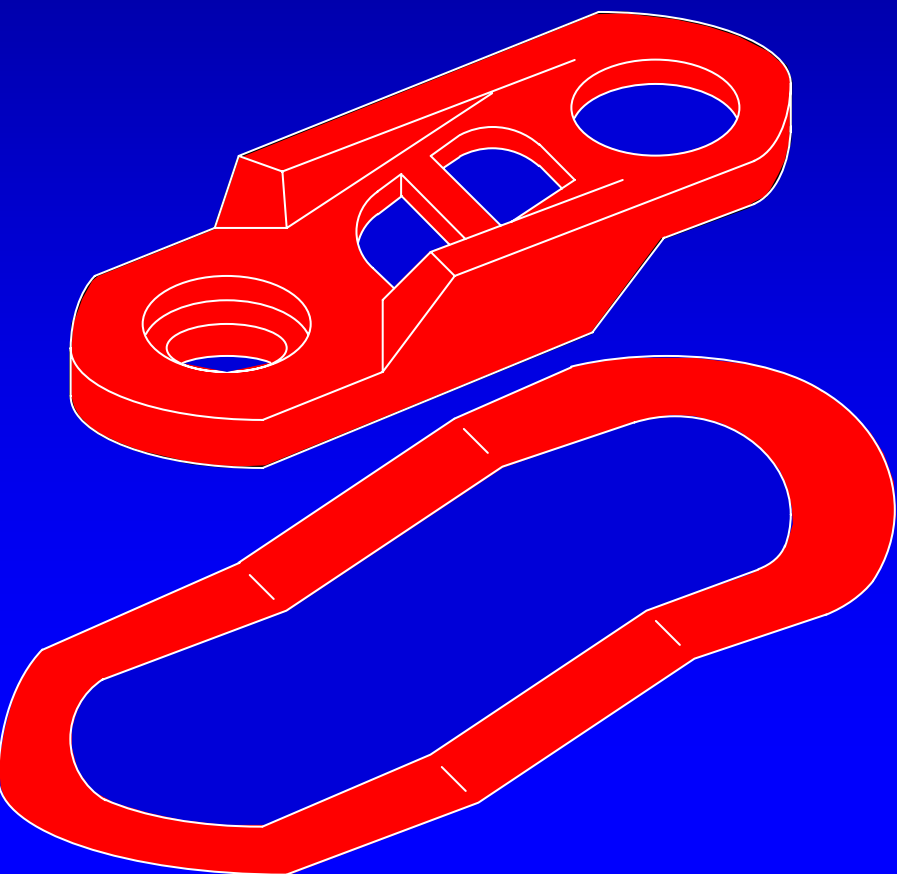

1. 鍛造工程

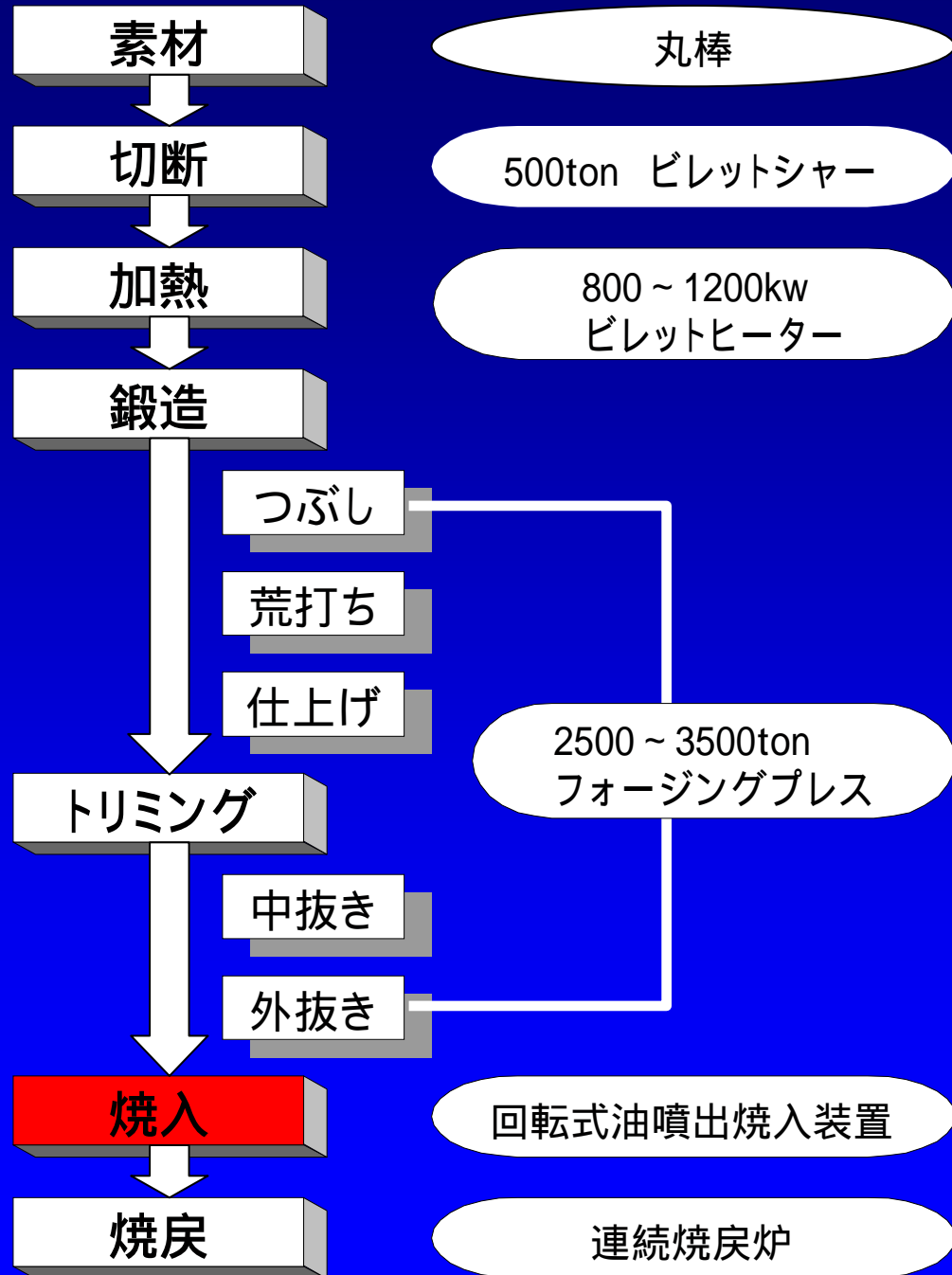
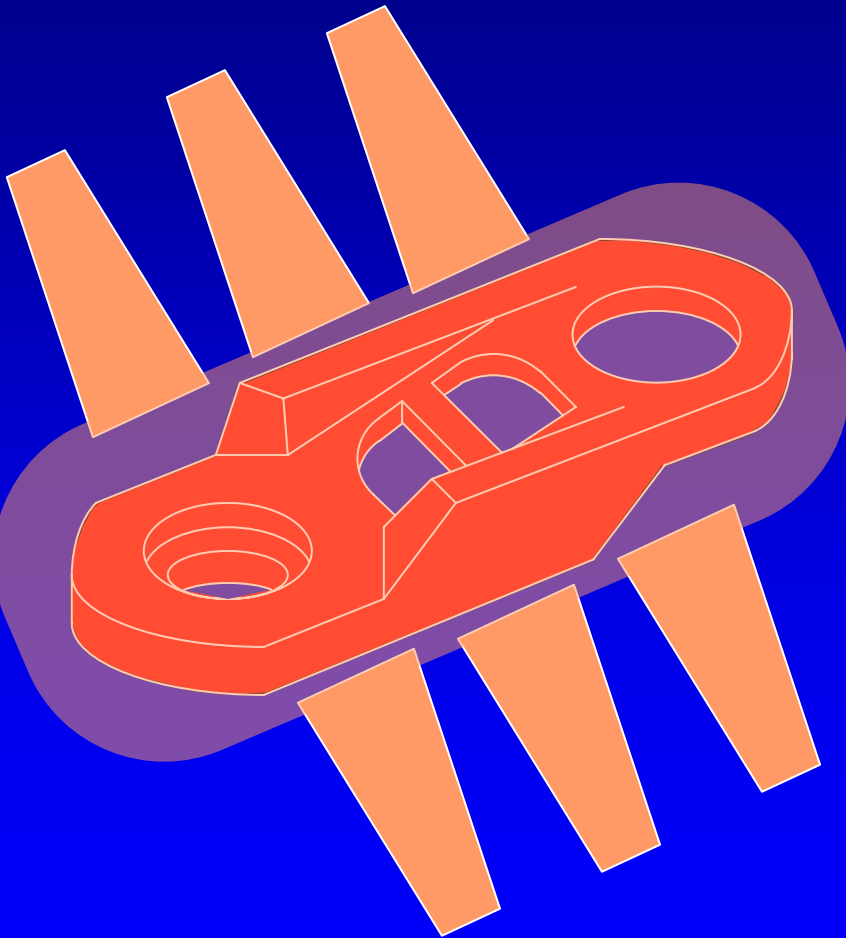

1. 鍛造工程

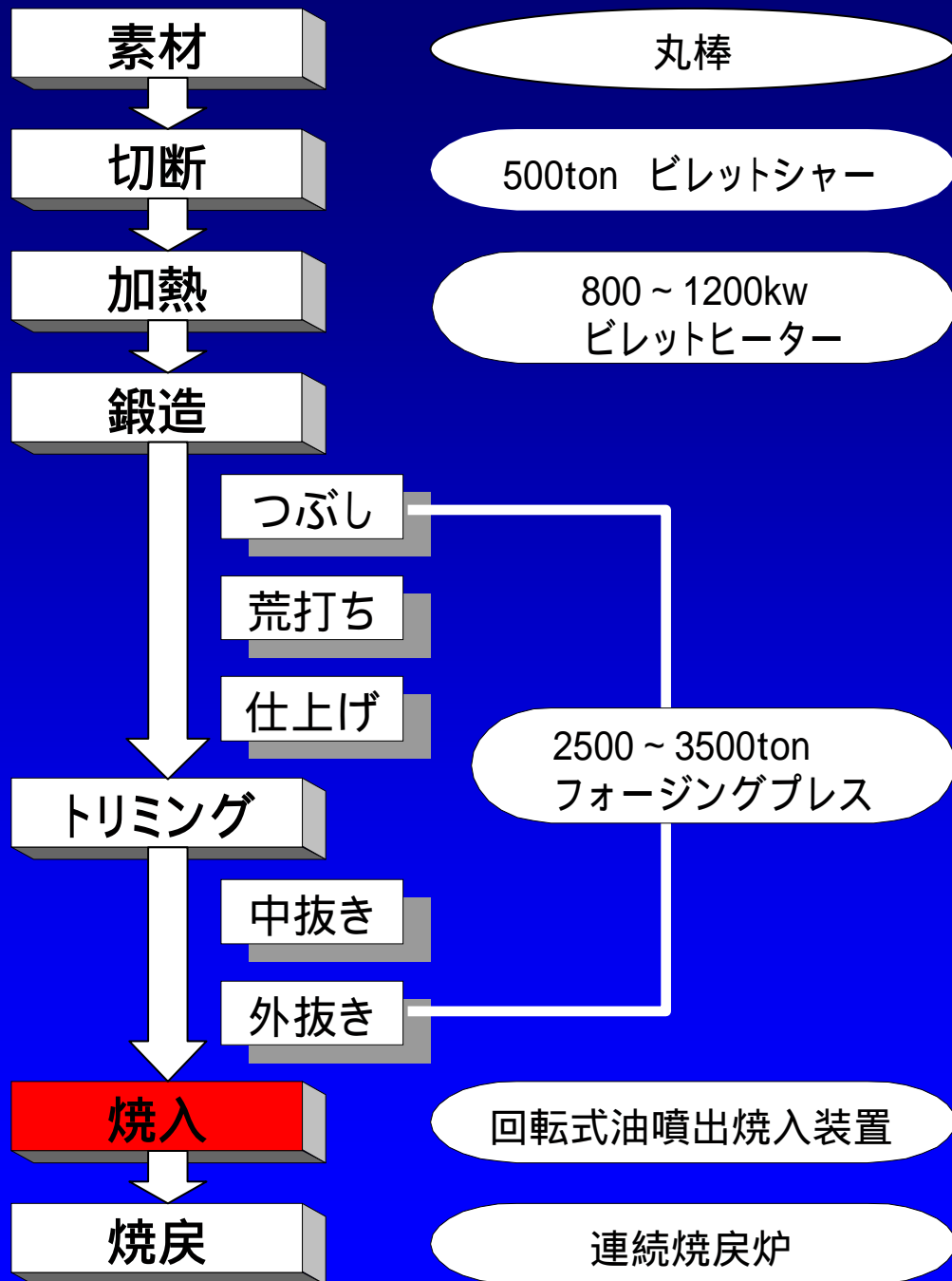
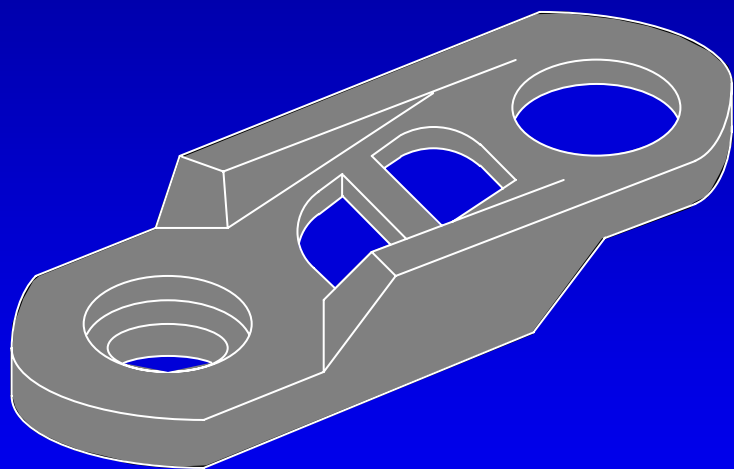

1. 鍛造工程

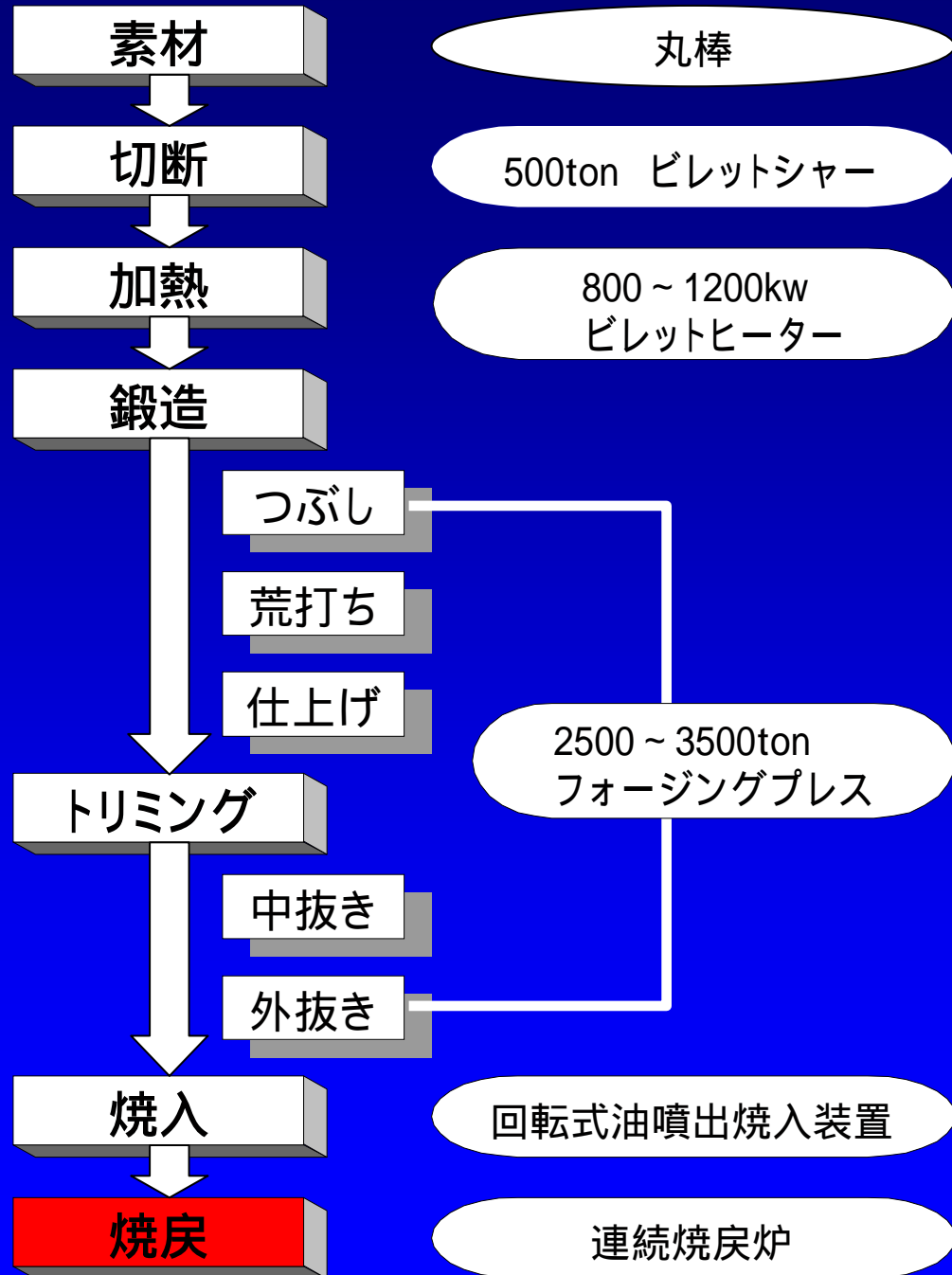
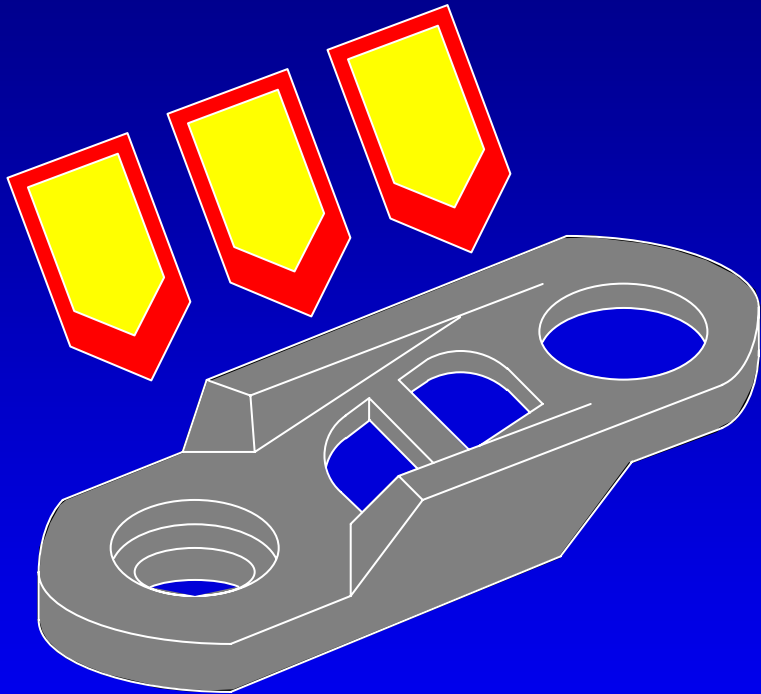

1. 鍛造工程

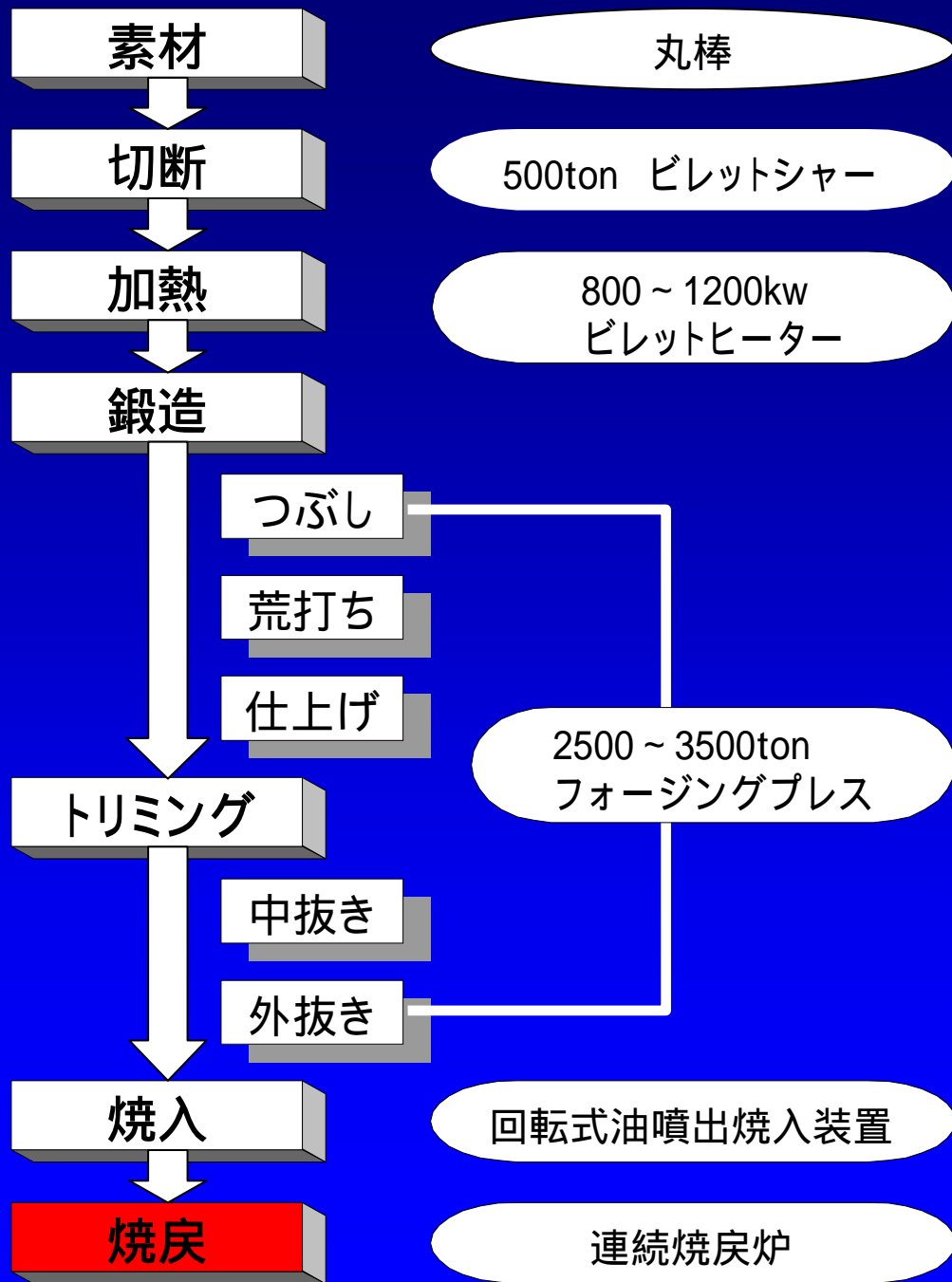
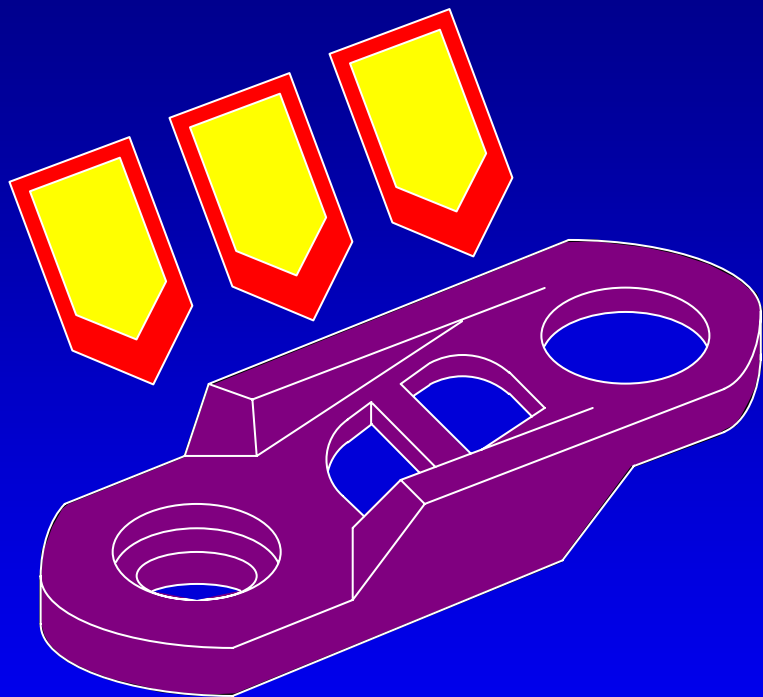

1. 鍛造工程

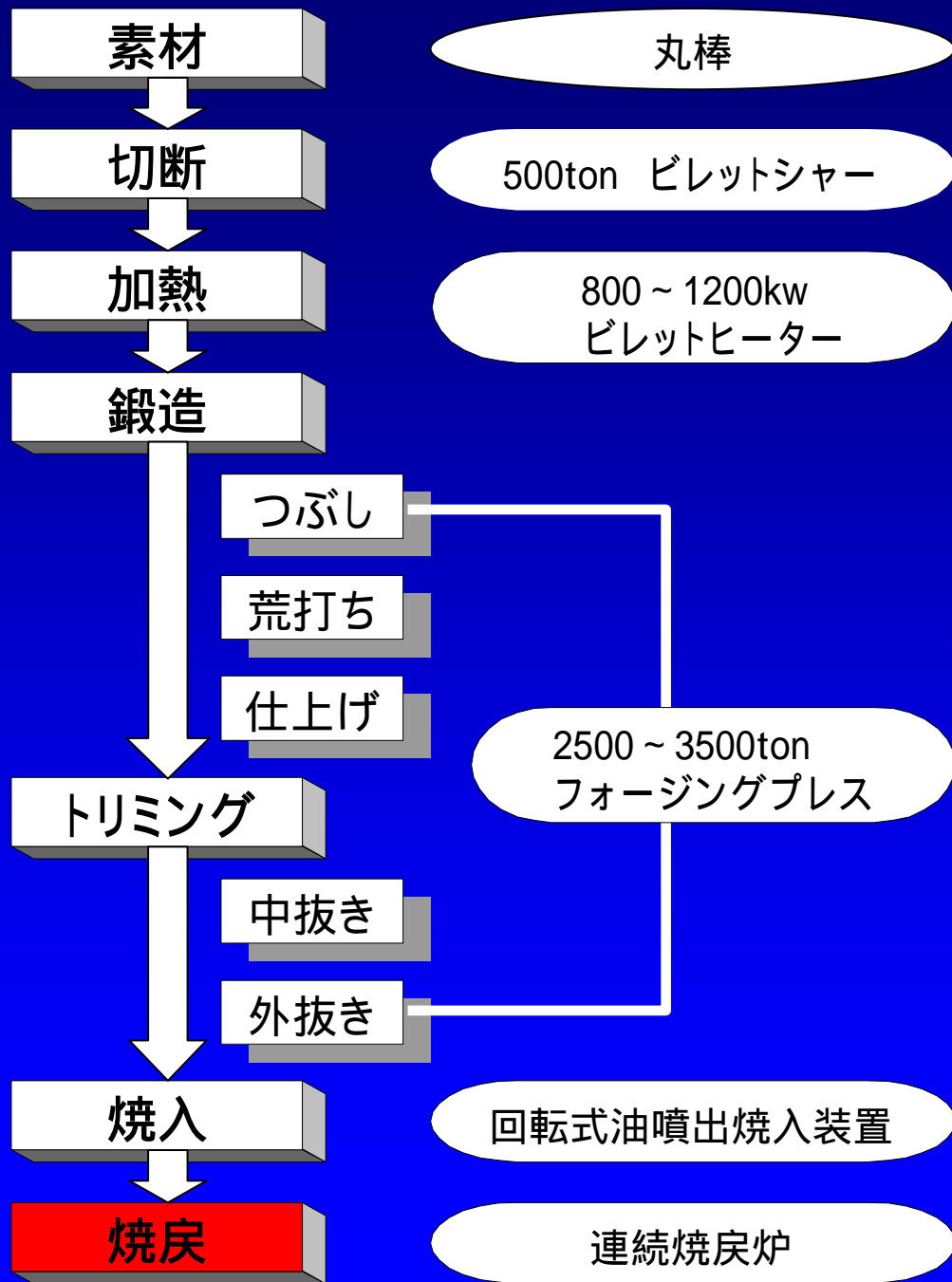
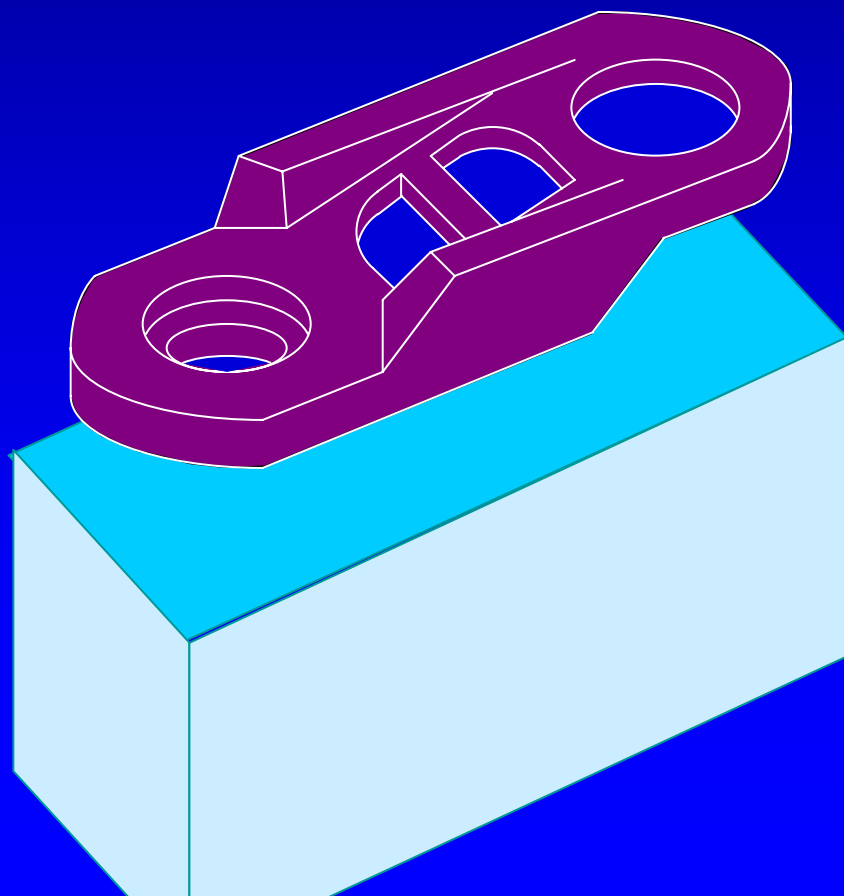

1. 鍛造工程

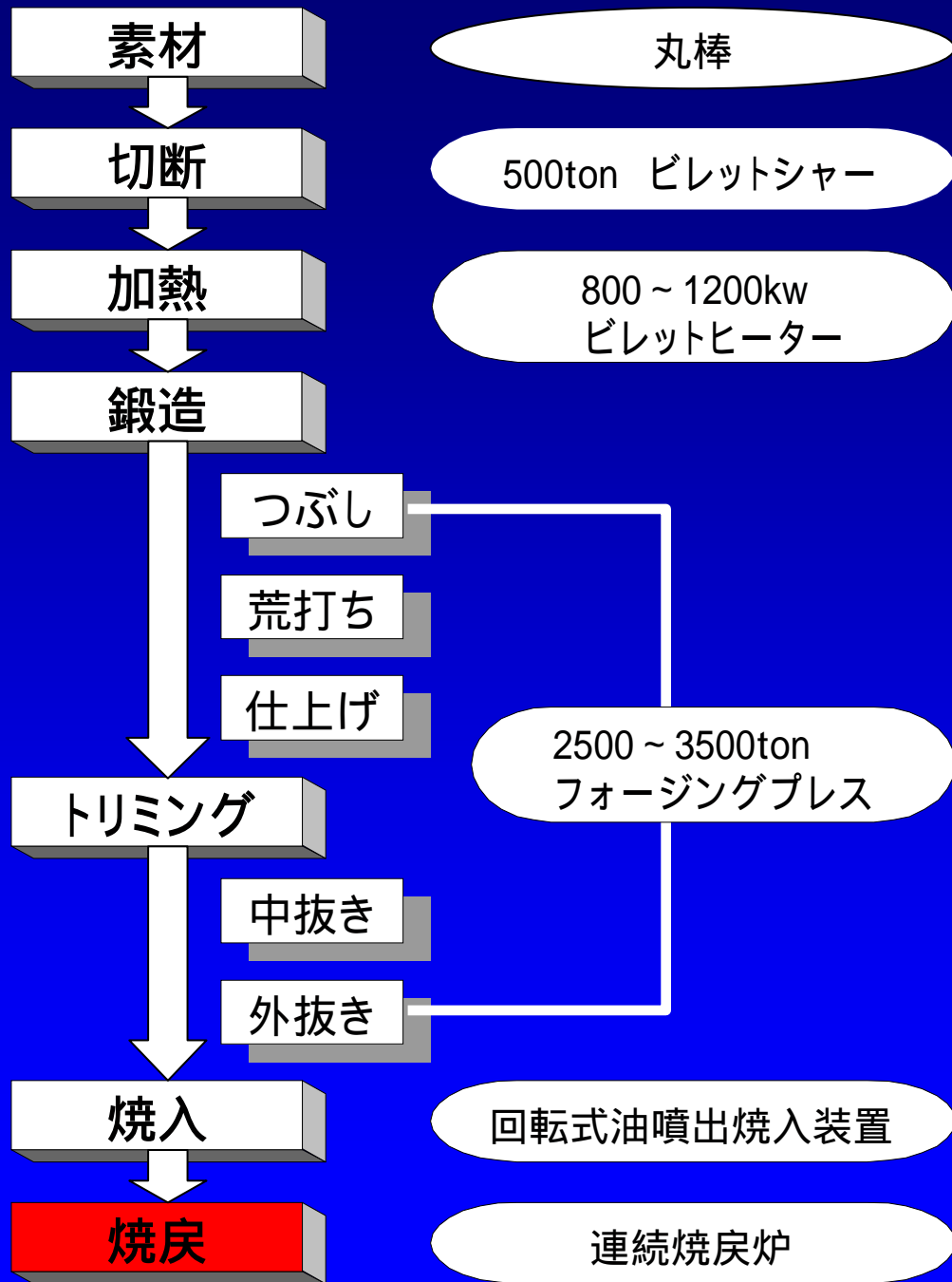
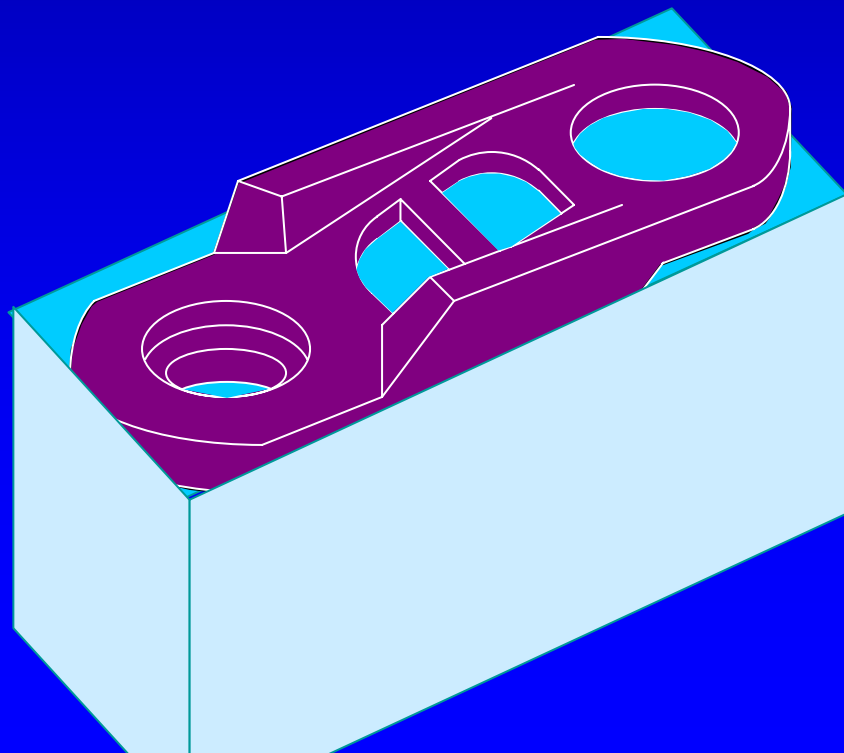

1. 鍛造工程

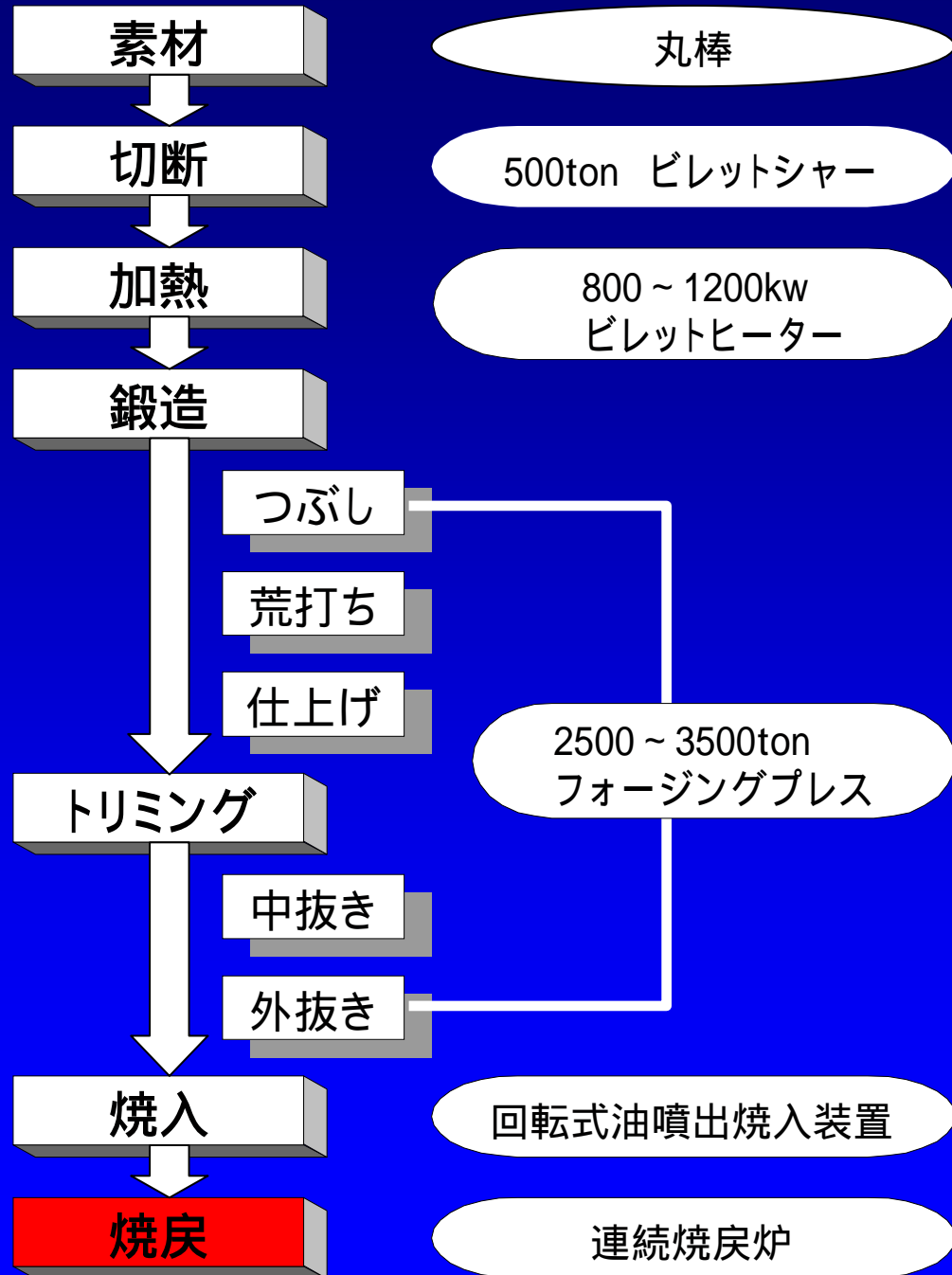
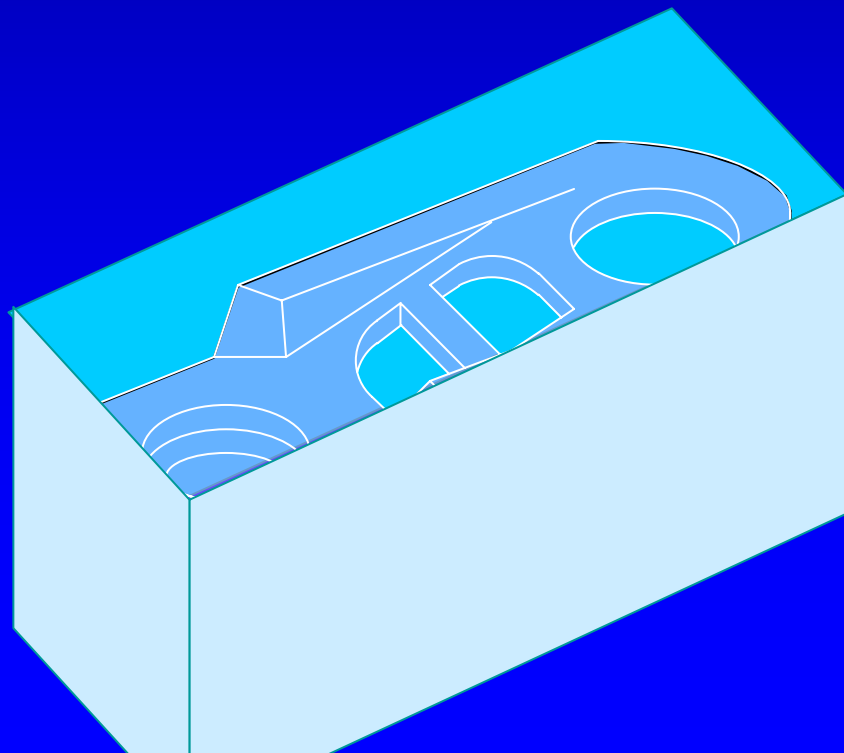

1. 鍛造工程

